



2021 catalog

For CO₂ and fiber laser consumables

Replacement parts suitable for LVD®



Centricut delivers

- OEM quality nozzles, ceramics and optics
- Technical and application support from our OEM-trained technicians
- 100% satisfaction guarantee

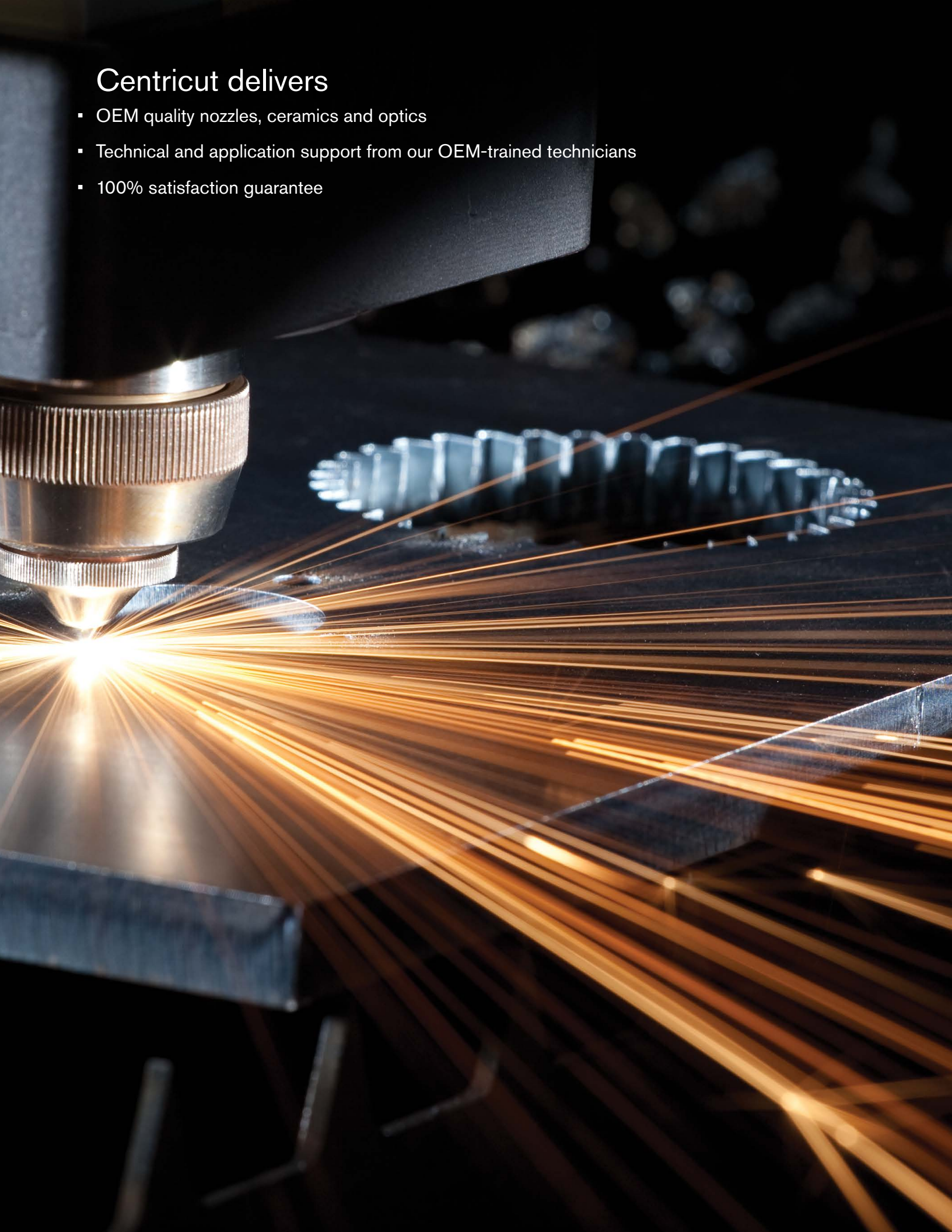

CO₂ and fiber laser nozzles

Nozzle options

All Centricut nozzles are engineered and manufactured to the highest standards. Select the OEM quality nozzle best suited for your application needs

Copper

Most commonly used nozzle offering good durability and nozzle life. Primary nozzle type for fiber lasers.

Chrome plated

Shiny, mirror-like finish provides increased spatter resistance, improved durability and longer life than copper nozzles. Not recommended for use on fiber lasers.

Look for CP in the part number to identify a chrome plated nozzle

Hard chrome plated

Premium nozzles offering the highest level of durability and longest nozzle life. These nozzles are not as shiny as chrome plated and have a dull appearance. Not recommended for use on fiber lasers.

Look for HCP in the part number to identify a hard chrome nozzle.

| | |
|---|---|
| CP (chrome plated) | Nozzles plated with chrome for increased durability. These nozzles are easier to clean, resist damage due to 'tip-ups' and have better spatter resistance over non-plated nozzles. For use in all laser cutting applications. |
| Conical | Conical internal geometry for high pressure, non-ferrous cutting applications using nitrogen, air or argon. |
| Cylindrical | Cylindrical internal geometry for low pressure, mild steel cutting applications using oxygen. |
| Double | Insert pressed into a standard cylindrical nozzle for improved edge quality, laminar gas flow and spatter resistance. Primarily used in mild steel applications. |
| HCP (hard chrome plated) | Enhanced durability chrome plated nozzles. These nozzles are easier to clean, resist damage due to 'tip-ups' and have better spatter resistance over non-plated nozzles. For use in all laser cutting applications. |
| HP (high pressure) HD (high density) | Conical style nozzle for high pressure, non-ferrous cutting applications using nitrogen, air or argon. |
| Inner | Also referred to as a 'nozzle insert'. Works in conjunction with an outer nozzle to create a double nozzle. Primarily used in mild steel applications. |
| Low pressure | Cylindrical style nozzle for low pressure, mild steel cutting applications using oxygen. |
| Outer | Works in conjunction with an inner nozzle to create a double nozzle. Primarily used in mild steel applications. |
| Shower | Nozzles with a center orifice surrounded by smaller jets. The smaller jets focus the assist gas into the kerf, creating improved edge quality and the ability to cut thicker material. Primarily used in mild steel applications. |

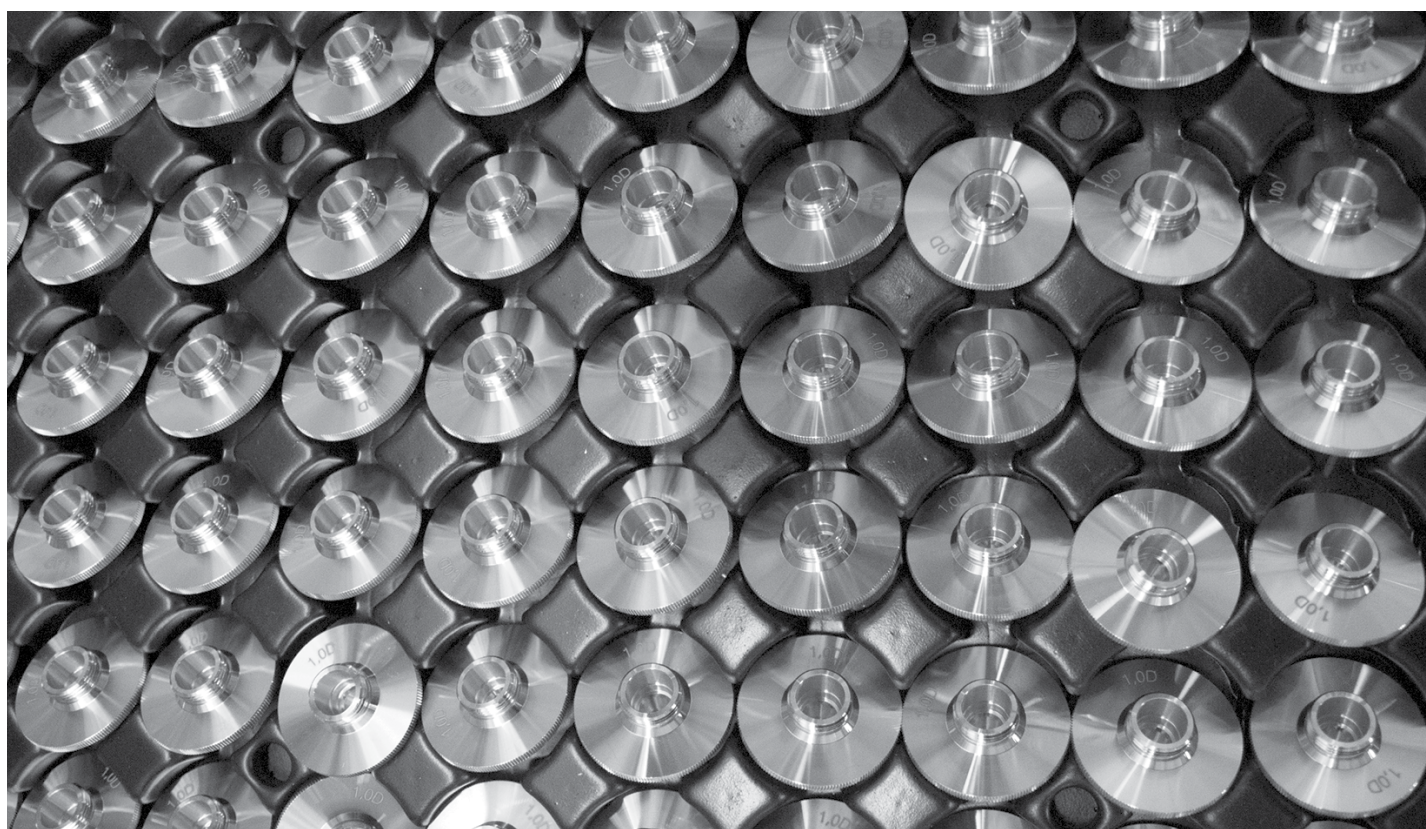

CO₂ and fiber laser optics

Optics key

| Lens | |
|------------|----------------------|
| MEN | Meniscus |
| PLX | Plano-convex |
| MTD | Mounted |
| Not MTD | Not mounted |
| PO | Plano |
| MP5 or ULA | Ultra low absorption |
| AR | Anti-reflection |
| ZNSE | Zinc selenide |
| FS | Fused silica |
| DIA | Diameter |
| FL | Focal length |
| ET | Edge thickness |
| WD | Working distance |

How to handle optics

Follow these easy steps, when cleaning or changing your optic, to help maximize the life and performance of your lens

- Avoid touching coated surfaces of the lens and hold the optic by its sides
- Wear powder-free finger cots or latex gloves when handling
- Do not use any tools or sharp objects when handling the optic or when removing it from its packaging
- Ensure the work surface is clean and free of oils, grease and dirt
- Do not place the optic on hard surfaces as they scratch easily
- Once the optic has been unpacked, carefully place it on the lens tissue in which it was originally wrapped

Optics disposal

It is important to dispose of used laser optics at a licensed industrial waste facility which is in compliance with all local, state, and federal regulations. If you don't have access to a licensed industrial waste facility, and purchased your laser optics through Centricut, you may return them to Centricut for proper disposal. This service is only available to Centricut customers.

All optics returned to Centricut must:

- Include return authorization and invoice numbers
- Be sealed in a plastic bag to minimize any hazards
- Remove excess ZnSe powder prior to sealing

*Acceptance of goods will be refused if not packaged correctly or if the return authorization number isn't included



Optics

| Centricut part number | Reference number | Type | Material | Diameter | Focal length | Edge thickness |
|-----------------------|--------------------------|---------|----------|----------|--------------|----------------|
| Fiber laser lens | | | | | | |
| NT375-7955 | | PLX | FS | 30 mm | 123 mm | 3.82 mm |
| TR300-9799 | 1869799 | PLX | FS | 30 mm | 146 mm | 8.0 mm |
| TR300-3107 | 1603107 | PLX | FS | 40 mm | 150 mm | 8.0 mm |
| AM313-0238 | 7710238, 71565737 | PLX | FS | 50.8 mm | 190 mm | 11.4 mm |
| SA384-0022 | 316-301-0022, 970128 | PLX | FS | 25.4 mm | 200 mm | 6.35 mm |
| SA384-0026 | 316-301-0026, ESTFLO2119 | PLX | FS | 38.1 mm | 210 mm | 6.35 mm |
| PR361-8988NM | 968988, 344631 | PLX | FS | 1.5" | 5.0" | .280" |
| MB312-8858 | | PLX | FS | 2.0" | 7.5" | .45" |
| PR361-0773 | 970773/M15-15-B X-SP-7MM | PLX MTD | FS | 1.5" | 5.0" | .275" |
| PR361-8988 | LH968988PVL, 576.41.005 | PLX MTD | FS | 1.5" | 5.0" | .280" |

| Centricut part number | Reference number | Material | Diameter | Edge thickness |
|-----------------------|--|----------|-----------|----------------|
| Fiber laser windows | | | | |
| PT317-1424 | P0588-1022-00001 | FS | 21.5 mm | 2.0 mm |
| PT317-0589 | 970397, 6930003260, P0589-360-00002, R26RT006410, R26ZC90110 | FS | 22.35 mm | 4.0 mm |
| PT317-9360 | 6930003260, P0589-360-00001 | FS | 22.35 mm | 4.0 mm |
| MB312-2336 | 632336-117 | FS | 25.4 mm | 4.0 mm |
| RT300-0035 NEW | 211LCG0035, 211LCG0037 | FS | 27.9 mm | 4.1 mm |
| PT317-0010 | P0253-1034-00001 | FS | 30.0 mm | 1.5 mm |
| TR300-6719 | 766719, P0795-1201-00002 | FS | 30.0 mm | 5.0 mm |
| SA384-0007 | 316-304-0007, ESTFLO01407, 632755-117 | FS | 32.0 mm | 6.35 mm |
| BY314-5979 NEW | 10086368, 10071591, 5335979 | Sapphire | 34.0 mm | 2.8 mm |
| TR300-4767 | 1614767 | FS | 34.0 mm | 4.9 mm |
| PR361-0089 | 1057.81000.089 | FS | 35.0 mm | 1.5 mm |
| BY314-5746 | 968752, 10045746, 10-02-01-5511 | QTZ | 36.0 mm | 5.0 mm |
| PR361-0474 | 970474 | FS | 37.0 mm | 4.0 mm |
| PT317-1551 | P0595-61551, P0595-58601-61551 | FS | 37.0 mm | 7.0 mm |
| PT317-1425 | SCR-01 | FS | 38.0 mm | 5.2 mm |
| CN307-3987 | 913987, 71598028 | FS | 38.1 mm | 1.6 mm |
| MZ315-6850 NEW | Z50ZZ016850 | FS | 42.0 mm | 9.0 mm |
| MZ315-5350 | Z50SA015350, W495 | FS | 42.0 mm | 9.0 mm |
| AM313-1308 | 71571308, 5172635 | FS | 45.0 mm | 3.0 mm |
| PT317-5919 | 77005919 | FS | 48.0 mm | 7.0 mm |
| PT317-1789 | 284.0402, 971789, 717062 | FS | 50.0 mm | 3.18 mm |
| MB312-0137 | 633744-137 | FS | 50.0 mm | 8.0 mm |
| AM313-0026 | 71570026 | FS | OCTAGONAL | 1.5 mm |

Centricut is not affiliated with the named manufacturers. Reference to machines, parts, descriptions, and model numbers are for convenience in verifying compatibility only. All parts are made by or for Centricut and are not made by the referenced manufacturers (unless expressly indicated). Centricut is a registered trademark of Hypertherm, Inc. All other trademarks are the properties of their respective owners.

| Centricut part number | Reference number | Type | Material | Diameter | Focal length | Edge thickness |
|--|--|------|----------|----------|--------------|----------------|
| CO ₂ lenses | | | | | | |
| TR300-0115 NEW (Cut - No RFID) | | MEN | ZNSE | 1.969" | 4.528" | .350" |
| TR300-0130 NEW (Cut - No RFID) | 400130LMA , 0380117, D40 Cut, 630790-117 | MEN | ZNSE | 1.575" | 5.118" | .295" |
| TR300-8123 NEW | 518123 | MEN | ZNSE | 1.575" | 6.102" | .295" |
| TR300-0175 NEW (Cut - No RFID) | 1330448, 62440 | MEN | ZNSE | 1.969" | 6.89" | .350" |
| TR300-0250 NEW (Cut - No RFID) | 400250LMA, 0380115, D40 Cut, 630789-117 | MEN | ZNSE | 1.575" | 9.842" | .295" |
| TR300-2500 NEW (Cut - No RFID) | 1330443, 62439 | MEN | ZNSE | 1.969" | 9.842" | .350" |
| LL342-1819 | 166634, 61819 | MEN | ZNSE | 1.1" | 5.0" | .236" |
| TR300-0163 | 350163, 861143, LMZ1.5-0.29-10.00-2048 | MEN | ZNSE | 1.5" | 10.0" | .290" |
| TR300-6477 | 726477 | MEN | ZNSE | 1.5" | 10.0" | .354" |
| BY314-0185 | 4-00185, 4-00372, 142375, 60603 | MEN | ZNSE | 1.5" | 3.75" | .236" |
| TR300-6104 | 346104, 61962, 831393 | MEN | ZNSE | 1.5" | 3.75" | .290" |
| BY314-0736 | 414323, 4-10736 | MEN | ZNSE | 1.5" | 3.75" | .354" |
| BY314-0186 | 60260, 507790, 4-00186, 110111 | MEN | ZNSE | 1.5" | 5.0" | .236" |
| TR300-8114 | 088114, 60696, 406294, 110109, 61014, 658108, 29100023, 6930001002 | MEN | ZNSE | 1.5" | 5.0" | .290" |
| BY314-5094 | 767963, 60615, 4-05094, 110113, 358186, 62710 | MEN | ZNSE | 1.5" | 5.0" | .354" |
| PR361-0004 | 62709, 621644, 120216 | MEN | ZNSE | 1.5" | 5.0" | .354" |
| PT317-0001 | 61851, 312370 | MEN | ZNSE | 1.5" | 7.5" | .125" |
| BY314-0187 | 784964, 60602, 4-00187, 110112 | MEN | ZNSE | 1.5" | 7.5" | .236" |
| TR300-7517 | 097517, 60697, 702232, 110110, 61983 | MEN | ZNSE | 1.5" | 7.5" | .290" |
| LL342-1171 | 61171 | MEN | ZNSE | 1.5" | 7.5" | .310" |
| BY314-5095 | 60616, 4-05095, 570721, 110114, 361129 | MEN | ZNSE | 1.5" | 7.5" | .354" |
| BY314-8637 | 698637 | MEN | ZNSE | 1.5" | 7.5" | .354" |
| TR300-1972 | 61961, 141972, 977976 | MEN | ZNSE | 1.5" | 8.85" | .290" |
| TR300-8123 | 518123 | MEN | ZNSE | 1.575" | 6.102" | .295" |
| LV333-0176 | 480176, 29100115 | MEN | ZNSE | 1.75" | 5.0" | .354" |
| LV333-1551 | 981551, LMZ2.0-0.380-10.0-2053, 29100061S | MEN | ZNSE | 2.0" | 10.0" | .380" |
| PT317-6326 | 206326 | MEN | ZNSE | 2.0" | 5.0" | .378" |
| LV333-1004 | 458138, LMZ2.0-0.380-5.00-2051, PLLMZ0024, 29100154 | MEN | ZNSE | 2.0" | 5.0" | .380" |
| CN307-2376 | 61405, 695399, 922376, 60698, 29100055 | MEN | ZNSE | 2.0" | 7.5" | .380" |
| AM313-0305 | 61161, 81140305, LPCZ-1.10-0.16-5.0-1044, PLLPZ0132, 561067 | PLX | ZNSE | 1.1" | 5.0" | .160" |
| AM313-6602 | 726602 | PLX | ZNSE | 1.1" | 7.5" | .160" |
| AM313-0657 | 600657, 71502030, LPCZ-1.5-0.30-10.0-1128 | PLX | ZNSE | 1.5" | 10.0" | .300" |
| TK374-2235 | 312235 | PLX | ZNSE | 1.5" | 12.5" | .300" |
| PT317-8950 | 148950 | PLX | ZNSE | 1.5" | 2.5" | .085" |
| MZ315-0130 | 60830, Z50MB000130, 962834, 766479 | PLX | ZNSE | 1.5" | 5.0" | .118" |
| TR300-0002 | 61163, LMZ1.5-0.16-5.00-2043, 706491, 907557, PLCZ-1.5-0.16-5.0-1116 | PLX | ZNSE | 1.5" | 5.0" | .160" |
| MZ315-0160 | 60770, 227092, Z50MB000130H, LPCZ-1.5-0.236-5.0-1122, 834-319-002 | PLX | ZNSE | 1.5" | 5.0" | .236" |
| PR361-9011 | 834-319-011, 60905, 658108, ZC15500300, Z50MB000400, 578662, MLL00016 | PLX | ZNSE | 1.5" | 5.0" | .300" |
| MB312-500 | W500, 60905, 110144, LPCZ-1.5-0.30-5.0-1125, PLLPZ0132 | PLX | ZNSE | 1.5" | 5.0" | .310" |
| CN307-8085 | 941031, 61001, 908085, ZC15513280, 110092, PLLPZ0033 | PLX | ZNSE | 1.5" | 5.0"WD | .280" |
| PR361-0003 | 60784, LPCZ-1.5-0.236-7.5-1123 | PLX | ZNSE | 1.5" | 7.5" | .236" |
| PR361-9012 | 834-319-012, 60906, 618938, 306068, 741363, 60882, 299133, 71501070NM, 62649 | PLX | ZNSE | 1.5" | 7.5" | .300" |
| MB312-018 | 60906, W018, 383862, 60906LA, W018, 62649ULA, 383862, 62649LA | PLX | ZNSE | 1.5" | 7.5" | .310" |
| CN307-9484 | 909484, 61002, 464497, 100096, LPCZ-1.5-0.280-5.13-1007, PLLPZ0052 | PLX | ZNSE | 1.5" | 7.5"WD | .280" |
| PT317-8275 | 628275, W502A, 630736-117 | PLX | ZNSE | 2.0" | 10.0" | .310" |
| PT317-0537 | 960537 | PLX | ZNSE | 2.0" | 10.0" | .380" |
| CN307-4498 | 154498, 926274 | PLX | ZNSE | 2.0" | 10.0"WD | .380" |
| TK374-7338 | 197338 | PLX | ZNSE | 2.0" | 11.25" | .310" |
| MZ315-5980 | 145980 | PLX | ZNSE | 2.0" | 5.0" | .300" |
| MB312-505 | W505, 110169, PLLPZ0162, 304725, 61003, Z50ZZ005160 | PLX | ZNSE | 2.0" | 5.0" | .310" |
| MZ315-0516A | 61019, Z50ZZ00516A, Z50ZZ013480, 81140307, 741363 | PLX | ZNSE | 2.0" | 5.0" | .380" |

Centricut is not affiliated with the named manufacturers. Reference to machines, parts, descriptions, and model numbers are for convenience in verifying compatibility only. All parts are made by or for Centricut and are not made by the referenced manufacturers (unless expressly indicated). Centricut is a registered trademark of Hypertherm, Inc. All other trademarks are the properties of their respective owners.

| Centricut part number | Reference number | Type | Material | Diameter | Focal length | Edge thickness |
|------------------------------------|--|---------|----------|----------|--------------|----------------|
| CO ₂ lenses (continued) | | | | | | |
| MZ315-3480HA | 158039, Z50ZZ013480 HIGH ACCURACY | PLX | ZNSE | 2.0" | 5.0" | .380" |
| CN307-0676 | 870676, 61514, LPCZ-2.0-0.38-5.19-1141, PLLPZ0116 | PLX | ZNSE | 2.0" | 5.0"WD | .380" |
| MZ315-3470HA | 769062, Z50ZZ013470 HIGH ACCURACY | PLX | ZNSE | 2.0" | 7.5" | .380" |
| NT375-4494 | 634494, LPCZ-2.0-0.30-7.5-1133 | PLX | ZNSE | 2.0" | 7.5" | .300" |
| MB312-510 | W510, 61004, 892020, 110122, PLLPZ0138 | PLX | ZNSE | 2.0" | 7.5" | .310" |
| MZ315-0520A | 61405, 232771, Z50ZZ00520A, MLL00018, Z50ZZ005200, Z50ZZ013470, 81140186 | PLX | ZNSE | 2.0" | 7.5" | .380" |
| CN307-1603 | 61515, 781603, LPCZ-2.0-0.38-7.67-1143, PLLPZ0115 | PLX | ZNSE | 2.0" | 7.5" WD | .380" |
| TK374-3478 | 541344, 263478, Z50ZZ00530A, LPCZ-2.0-0.31-7.45-1137 | PLX | ZNSE | 2.0" | 8.75" | .310" |
| TK374-6670 | 236670, 61690, Z50ZZ00550A | PLX | ZNSE | 2.5" | 10.0" | .390" |
| TK374-1592 | 178937 | PLX | ZNSE | 2.5" | 11.25" | .310" |
| TK374-8593 | 828593 | PLX | ZNSE | 2.5" | 12.5" | .390" |
| TK374-3827 | 243827, Z50ZZ00540A, LPCZ-2.5-0.31-8.75-1145 | PLX | ZNSE | 2.5" | 8.75" | .310" |
| AM313-0221 | 81140221, 6067639 | PLX MTD | ZNSE | 1.5" | 3.75" | .300" |
| AM313-0306 | 81140306, 65024, 578662/M16-15-1C-P5.0, PLLPZ0133, 6874793 | PLX MTD | ZNSE | 1.5" | 5.0" | .300" |
| AM313-1216 | 578662/M20-15-1C-P5.0, 9001216A, 71501072, 7973109, 6360374 | PLX MTD | ZNSE | 1.5" | 5.0" | .300" |
| AM313-8662 | 578662/M21-15-1C-P5.0, 6060415 | PLX MTD | ZNSE | 1.5" | 5.0" | .300" |
| AM313-9830 | 65101, 578662, 6547252 | PLX MTD | ZNSE | 1.5" | 5.0" | .300" |
| AM313-1215 | 9001215A, 306068/M21-15-1C-P7.5, 7973110, 71501070, 6395647 | PLX MTD | ZNSE | 1.5" | 7.5" | .300" |
| AM313-9831 | 71369831, 65102, 6550214 | PLX MTD | ZNSE | 1.5" | 7.5" | .300" |
| AM313-10F1 | 680154-001, 71710061, 6021844 | PLX MTD | ZNSE | 2.0" | 10.0" | .380" |
| AM313-0307 | 65035, 81140307, 741363, 6068456 | PLX MTD | ZNSE | 2.0" | 5.0" | .380" |
| AM313-50F1 | 71710059, 741363M30-20-1C-P5.0, 6296946 | PLX MTD | ZNSE | 2.0" | 5.0" | .380" |
| AM313-0400 | 306068, 65025, 81140400, 6022704 | PLX MTD | ZNSE | 2.0" | 7.5" | .300" |
| AM313-0186 | 65038, 81140186, PLLPZ0156, 6068413 | PLX MTD | ZNSE | 2.0" | 7.5" | .380" |
| AM313-75F1 | 232771M31-20-1C-P7.5, 71710030, 6243925 | PLX MTD | ZNSE | 2.0" | 7.5" | .380" |
| BY314-7014MP5 | 460386, 4-07014 | MEN | ZNSE MP5 | 1.5" | 10.0" | .354" |
| BY314-0186MP5 | 4-00186, 528717, 60260LA | MEN | ZNSE MP5 | 1.5" | 5.0" | .236" |
| TR300-8114MP5 | 60696LA, 312503, 29100023, 88114, PLLPZ0125B | MEN | ZNSE MP5 | 1.5" | 5.0" | .290" |
| BY314-5094MP5 | 123397, 4-07475, 60615LA, LMZ1.5-0.354-5.0-2008 | MEN | ZNSE MP5 | 1.5" | 5.0" | .354" |
| BY314-0187MP5 | 714512, 60602LA, 4-00187 | MEN | ZNSE MP5 | 1.5" | 7.5" | .236" |
| TR300-7517MP5 | 60697LA, 97517, 474644, PLLPZ0126B | MEN | ZNSE MP5 | 1.5" | 7.5" | .290" |
| BY314-5095MP5 | 602033, 60616LA, 4-07476, LMZ1.5-0.354-7.5-2009, PLLPZ0130B, 62710 | MEN | ZNSE MP5 | 1.5" | 7.5" | .354" |
| BY314-8294MP5 | 996707, 10048294 | MEN | ZNSE MP5 | 1.5" | 9.0" | .354" |
| HW405-4913 | 114913 | MEN | ZNSE MP5 | 2.0" | 10.0" | .379" |
| HW405-5270 | 355270 | MEN | ZNSE MP5 | 2.0" | 5.0" | .378" |
| HW405-7143 | 527143, 467572, 60698LA, 291005-5, 308332, PLLMZ0025B | MEN | ZNSE MP5 | 2.0" | 7.5" | .379" |
| MZ315-0160MP5 | 60770LA, 857048, Z50MB000160 | PLX | ZNSE MP5 | 1.5" | 5.0" | .236" |
| MZ315-0400MP5 | 106106, PLLPZ0132B, 60905LA, Z50MB000400, 62670ULA | PLX | ZNSE MP5 | 1.5" | 5.0" | .300" |
| CN307-8085MP5 | 61001LA, 794914, 908085, | PLX | ZNSE MP5 | 1.5" | 5.0"WD | .280" |
| MB312-018MP5 | 383862 | PLX | ZNSE MP5 | 1.5" | 7.5" | .300" |
| CN307-9484MP5 | PLLPZ0052B | PLX | ZNSE MP5 | 1.5" | 7.5"WD | .315" |
| MB312-505MP5 | 61003LA, 922203, W505 | PLX | ZNSE MP5 | 2.0" | 5.0" | .310" |
| AM313-0307NMP5 | 81140307, 61019LA, 753010 | PLX | ZNSE MP5 | 2.0" | 5.0" | .380" |
| CN307-0211MP5 | 540211, 61019LA, 922377 | PLX | ZNSE MP5 | 2.0" | 5.0"WD | .380" |
| MB312-510MP5 | 61004LA, 635061, W510, | PLX | ZNSE MP5 | 2.0" | 7.5" | .310" |
| CN307-2376MP5 | 329011, 922376, 61515ULA, | PLX | ZNSE MP5 | 2.0" | 7.5" | .380" |
| MZ315-0520AMP5 | 392125, 61405LA, Z50ZZ000520A, PLLPZ0135B, 81140186 61405ULA | PLX | ZNSE MP5 | 2.0" | 7.5" | .380" |

Centricut is not affiliated with the named manufacturers. Reference to machines, parts, descriptions, and model numbers are for convenience in verifying compatibility only. All parts are made by or for Centricut and are not made by the referenced manufacturers (unless expressly indicated). Centricut is a registered trademark of Hypertherm, Inc. All other trademarks are the properties of their respective owners.

| Centricut part number | Reference number | Type | Material | Diameter | Focal length | Edge thickness |
|------------------------------------|---|---------|----------|----------|--------------|----------------|
| CO ₂ lenses (continued) | | | | | | |
| AM313-0306MP5 | 65024LA, 81140306, 106106, M16-15-1C-P5.0, 6936448 | PLX MTD | ZNSE MP5 | 1.5" | 5.0" | .300" |
| AM313-1216MP5 | 106106, M20-15-1C-P5.0, 6071896 | PLX MTD | ZNSE MP5 | 1.5" | 5.0" | .300" |
| AM313-9830MP5 | 71369830, 106106, 65101LA, 106106/M16-15-1C-P5.0-A2-NI-1A | PLX MTD | ZNSE MP5 | 1.5" | 5.0" | .300" |
| AM313-0400MP5 | 65025LA, 383862/M16-15-1C-P7.5-A2-NI-1A, 81140400, 383862 | PLX MTD | ZNSE MP5 | 1.5" | 7.5" | .300" |
| AM313-1215MP5 | M21-15-1C-P7.5, 383862, 6071853 | PLX MTD | ZNSE MP5 | 1.5" | 7.5" | .300" |
| AM313-9831MP5 | 65102LA, 71369831, 383862 | PLX MTD | ZNSE MP5 | 1.5" | 7.5" | .300" |
| AM313-0307MP5 | 81140307, M16-20-1C-P5.0, 753010, 65035LA, 753010M16-20-1C-P5.0 | PLX MTD | ZNSE MP5 | 2.0" | 5.0" | .380" |
| AM313-0186MP5 | 392125, 65038LA, M16-20-1C-P7.5, 81140186, 6816292 | PLX MTD | ZNSE MP5 | 2.0" | 7.5" | .380" |

Accessories

| Centricut part number | Reference number | Description | Pkg qty |
|-----------------------|------------------|--|---------|
| TR300-6452 | | Lens cleaning Tiffen paper (50 pcs) | 1 |
| TR300-1115 | | Lens cleaning pre-cut cotton (100 pcs) | 1 |
| TR300-1010 | | Dropper, lens cleaning fluid | 1 |
| TR300-1112 | | Optical cleaning fluid | 1 |
| TR300-0699 | 70675699 REVA | Lens cleaning swabs (25 pcs) | 1 |
| TR300-7991 | 27991 | Polyester wipes 4" x 4" (100 pcs) | 1 |
| TR301-0282 | | Injector | 1 |
| TR300-LSA | | Lens stress analyzer | 1 |
| TR300-255 | | Magnifying loop | 1 |
| TR300-271 | | Base, mirror maintenance | 1 |
| TR300-7388 | 787388 | Mirror polish .1UM 250ML | 1 |
| MZ335-115 | ALI115/M | MZ-Wire, Indium .8 mm x 125 mm 1.5" Lens | 1 |
| MZ335-120 | ALI120/M | MZ-Wire, Indium .8 mm x 160 mm 2.0" Lens | 1 |

Centricut is not affiliated with the named manufacturers. Reference to machines, parts, descriptions, and model numbers are for convenience in verifying compatibility only. All parts are made by or for Centricut and are not made by the referenced manufacturers (unless expressly indicated). Centricut is a registered trademark of Hypertherm, Inc. All other trademarks are the properties of their respective owners.

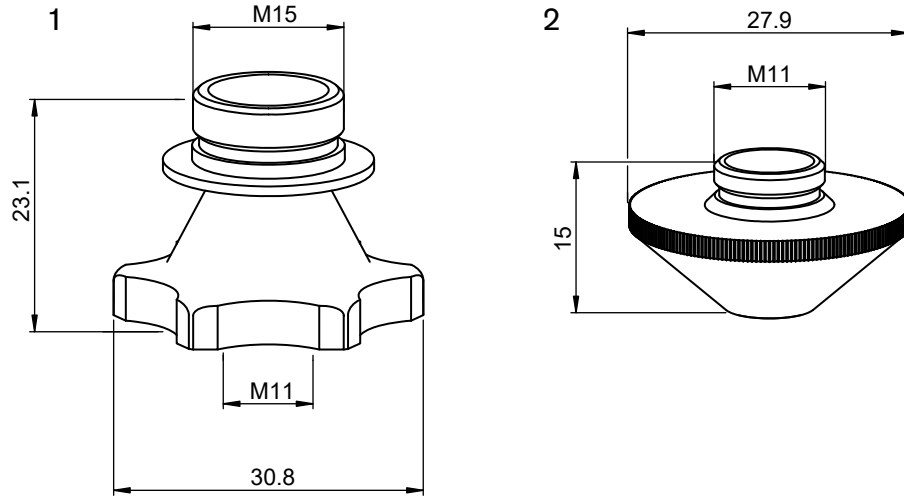

Consumables

| | Centricut part number | Esse A part number | Reference number | Description | Pkg qty |
|---|-----------------------|--------------------|------------------|-----------------------|---------|
| 1 | LV333-9093 NEW | AL595 | M000079093 | Nozzle holder adapter | 1 |
| | LV333-2154 NEW | L2440 | M000112154 | Nozzle 4.0mm CH 6.0 | 1 |
| 2 | LV333-2153 NEW | L2450 | M000112153 | Nozzle 5.0mm CH 7.0 | 1 |
| | LV333-2155 NEW | L2460 | M000112155 | Nozzle 6.0mm CH 8.0 | 1 |

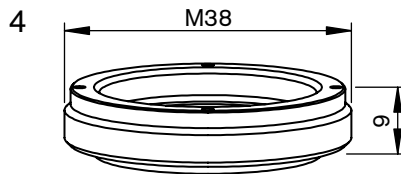
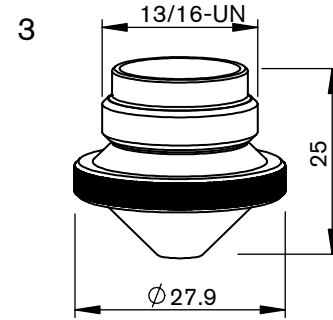
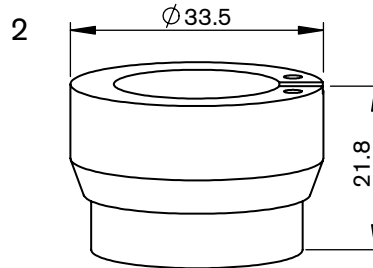
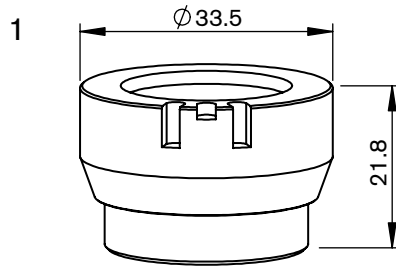
Consumables

| | Centricut part number | Esse A part number | Reference number | Description | Pkg qty |
|---|------------------------|--------------------|-----------------------------------|--|---------|
| 1 | PT311-1146 | AL130/S | 281146, P0380-211-00001, 29100033 | PT-Nozzle holder ITM 1.5" DZ | 1 |
| | PT311-1146OEM | AL130 | 281146, P0380-211-00001, 29100033 | PT-Nozzle holder ITM 1.5" DZ OEM | 1 |
| 2 | PT311-0298 | AL298 | P0497-68871, P0497-615-00001 | PT-Nozzle holder KTM 1.5" DXN, Ceramic | 1 |
| 3 | LV332-1993V | L20757 | D5241993 | LV-Nozzle cylindrical, 0.8 mm (5 pk)* | 5 |
| | LV332-5470V | L20141 | D7945470 | LV-Nozzle cylindrical, 1.0 mm (5 pk)* | 5 |
| | LV332-0001V | L20758 | D5241982 | LV-Nozzle cylindrical, 1.2 mm (5 pk)* | 5 |
| | LV332-5434V | L20142 | D7945434 | LV-Nozzle cylindrical, 1.5 mm (5 pk)* | 5 |
| | LV332-5452V | L20143 | D7945452 | LV-Nozzle cylindrical, 2.0 mm (5 pk)* | 5 |
| | LV332-5517V | L20144 | D7945517 | LV-Nozzle cylindrical, 2.5 mm (5 pk)* | 5 |
| | LV332-5518V | L20145 | | LV-Nozzle cylindrical, 3.0 mm (5 pk)* | 5 |
| | LV332-1993CPV | L20757X | D5241993 | LV-Nozzle cylindrical, 0.8 mm CP (5 pk) | 5 |
| | LV332-5470CPV | L20141X | D7945470 | LV-Nozzle cylindrical, 1.0 mm CP (5 pk)* | 5 |
| | LV332-0001CPV | L20758X | D5241982 | LV-Nozzle cylindrical, 1.2 mm CP (5 pk)* | 5 |
| | LV332-5434CPV | L20142X | D7945434 | LV-Nozzle cylindrical, 1.5 mm CP (5 pk)* | 5 |
| | LV332-5452CPV | L20143X | D7945452 | LV-Nozzle cylindrical, 2.0 mm CP (5 pk)* | 5 |
| | LV332-5517CPV | L20144X | D7945517 | LV-Nozzle cylindrical, 2.5 mm CP (5 pk) | 5 |
| | LV332-5518CPV | L20145X | | LV-Nozzle cylindrical, 3.0 mm CP (5 pk)* | 5 |
| 4 | PT347-4297 | AL198 | P0492-702-00001, 29100021 | PT-Insulating ring outer body | 1 |
| | PT311-0001 | AL201 | P0492-702-00002 | PT-Insulating ring | 1 |
| 5 | PT347-0101 | AL204 | P0360-100-00500, 46713300100 | PT-Sensor head connecting cable OEM | 1 |
| | AM326-6453 (not shown) | AL94 | 71366453 | AM-O-ring for outer nozzle | 1 |

* Centricut parts available in single packs. To order single packs, remove the 'V' at the end of the part number (e.g. LV123-4567V would be LV123-4567).
 For Esse A parts available in single packs. To order single packs, remove the '20' after the L in the part number (e.g. L20757 would be L757).

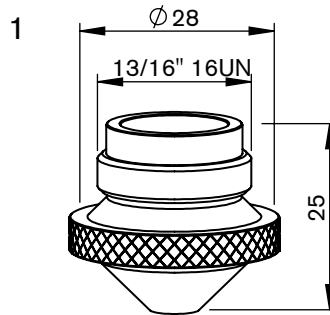

Consumables

| | Centricut part number | Esse A part number | Reference number | Description | Pkg qty |
|---|-----------------------|--------------------|-----------------------|---|---------|
| | LV332-1863V | L20151 | D5241863 | LV-Nozzle conical HD, 1.0 mm (5 pk)* | 5 |
| | LV332-1982V | L20759 | | LV-Nozzle conical HD, 1.2 mm (5 pk)* | 5 |
| | LV332-1862V | L20152 | D5241862 | LV-Nozzle conical HD, 1.5 mm (5 pk)* | 5 |
| | LV332-2512V | L20748 | D5242512 | LV-Nozzle conical HD, 1.7 mm (5 pk)* | 5 |
| | LV332-1855V | L20146 | D5241855 | LV-Nozzle conical HD, 2.0 mm (5 pk)* | 5 |
| | LV332-2513V | L20749 | D5242513, Z000000539D | LV-Nozzle conical HD, 2.3 mm (5 pk)* | 5 |
| | LV332-1856V | L20147 | D5241856, Z000000563B | LV-Nozzle conical HD, 2.5 mm (5 pk)* | 5 |
| | LV332-1857V | L20148 | D5241857, Z000000540B | LV-Nozzle conical HD, 3.0 mm (5 pk)* | 5 |
| | LV332-1877V | L20149 | D5241877, Z000000564B | LV-Nozzle conical HD, 3.5 mm (5 pk)* | 5 |
| | LV332-1878V | L20283 | D5241878, Z000000565B | LV-Nozzle conical HD, 4.0 mm (5 pk)* | 5 |
| | LV332-2531V | L201303 | D5242531, Z000000566B | LV-Nozzle conical HD, 4.5 mm (5 pk)* | 5 |
| 1 | LV332-2535V | L201304 | D5242535, Z000000567B | LV-Nozzle conical HD, 5.0 mm (5 pk)* | 5 |
| | LV332-2536V | L201305 | D5242536, Z000000568B | LV-Nozzle conical HD, 6.0 mm (5 pk)* | 5 |
| | LV332-1863CPV | L20151X | D5241863 | LV-Nozzle conical HD, 1.0 mm CP (5 pk) | 5 |
| | LV332-1982CPV | L20759X | | LV-Nozzle conical HD, 1.2 mm CP (5 pk) | 5 |
| | LV332-1862CPV | L20152X | D5241862 | LV-Nozzle conical HD, 1.5 mm CP (5 pk)* | 5 |
| | LV332-2512CPV | L20748X | D5242512 | LV-Nozzle conical HD, 1.7 mm CP (5 pk) | 5 |
| | LV332-1855CPV | L20146X | D5241855 | LV-Nozzle conical HD, 2.0 mm CP (5 pk)* | 5 |
| | LV332-2513CPV | L20749X | D5242513 | LV-Nozzle conical HD, 2.3 mm CP (5 pk)* | 5 |
| | LV332-1856CPV | L20147X | D5241856, Z000000563B | LV-Nozzle conical HD, 2.5 mm CP (5 pk)* | 5 |
| | LV332-1857CPV | L20148X | D5241857, Z000000540 | LV-Nozzle conical HD, 3.0 mm CP (5 pk)* | 5 |
| | LV332-1877CPV | L20149X | D5241877 | LV-Nozzle conical HD, 3.5 mm CP (5 pk) | 5 |
| | LV332-1878CPV | L20283X | D5241878 | LV-Nozzle conical HD, 4.0 mm CP (5 pk) | 5 |

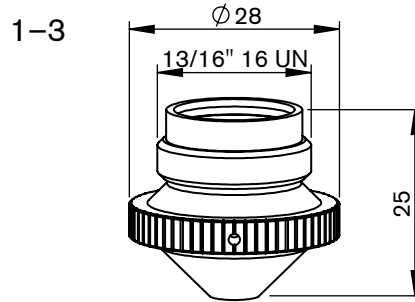
* Centricut parts available in single packs. To order single packs, remove the 'V' at the end of the part number (e.g. LV123-4567V would be LV123-4567).
 For Esse A parts available in single packs. To order single packs, remove the '20' after the L in the part number (e.g. L20757 would be L757).

Consumables

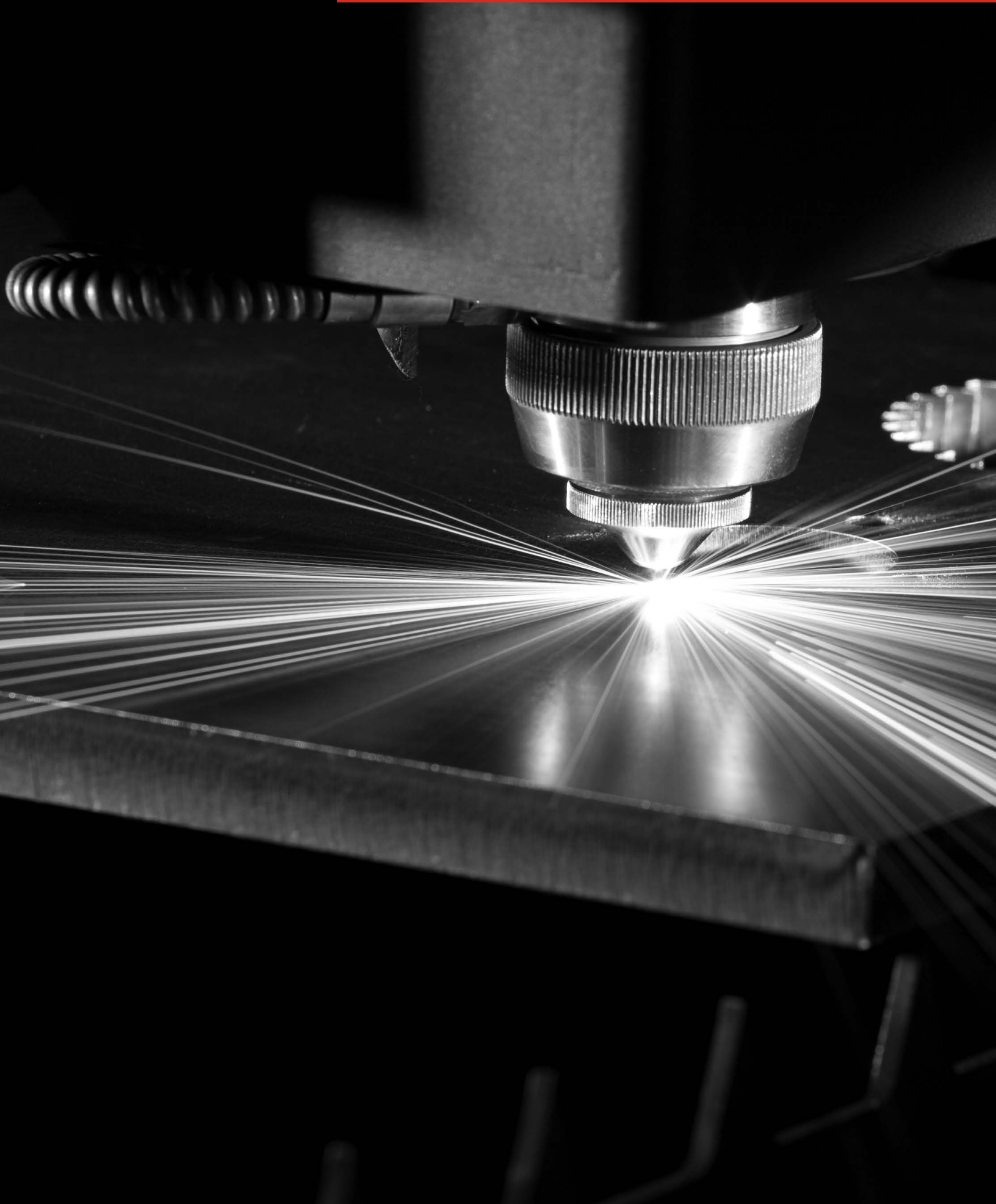
| | Centricut part number | Esse A part number | Reference number | Description | Pkg qty |
|---|-----------------------|--------------------|------------------|---|---------|
| 1 | LV332-3013 | L1293 | G8040182 | LV-Nozzle double w/spring, 3.0 mm/inner 1.3 mm | 1 |
| | LV332-3015 | L1294 | | LV-Nozzle double w/spring, 3.0 mm/inner 1.5 mm | 1 |
| | LV332-0132 | L1292 | G8040132 | LV-Nozzle double w/spring, 3.0 mm/inner 2.0 mm | 1 |
| | LV332-0013CP | L1290X | G8040180 | LV-Nozzle double w/spring, 2.5 mm/inner 1.3 mm CP | 1 |
| | LV332-0180CP | L1291X | G8040135 | LV-Nozzle double w/spring, 2.5 mm/inner 1.5 mm CP | 1 |
| 2 | LV417-0002 | L782 | 29100307 | LV-Nozzle double, 1.2 mm | 1 |
| | LV417-0003 | L784 | 29100304 | LV-Nozzle double, 1.5 mm | 1 |
| | LV417-0004 | L785 | 29100307 | LV-Nozzle double, 2.0 mm | 1 |
| | LV410-0180 | L786 | 29100305D | LV-Nozzle double, 2.5 mm | 1 |
| | LV417-0006 | L787 | 29100306 | LV-Nozzle double, 3.0 mm | 1 |
| | LV417-0008 | L789 | | LV-Nozzle double, 4.0 mm | 1 |
| | LV417-0003CP | L784X | | LV-Nozzle double, 1.5 mm CP | 1 |
| | LV417-0004CP | L785X | | LV-Nozzle double, 2.0 mm CP | 1 |
| | LV417-0005CP | L786X | | LV-Nozzle double, 2.5 mm CP | 1 |
| 3 | LV332-1297 | L885 | Z000001297 | LV-Nozzle double, 4.0 mm/inner 2.0 mm | 1 |
| | LV332-1344 | L886 | Z000001344 | LV-Nozzle double, 5.0 mm/inner 2.0 mm | 1 |
| | LV332-0131 | L790 | G8040131 | LV-Nozzle double, 3.0 mm/inner 2.0 mm | 1 |



Sensor cones



Centricut sensor cones provide substantial cost savings without sacrificing performance or quality

- Available for Amada, Mazak, Mitsubishi and Precitec
- Delivers the same OEM performance at a lower cost
- Unmatched performance and reliability
- Engineered and manufactured to Hypertherm's precise quality standards
- Backed by our one-year warranty and 100% satisfaction guarantee

| Centricut part number | Esse A part number | OEM | Reference number | Description |
|-----------------------|--------------------|------------|---|-----------------------------------|
| AM343-0091 | AL600 | Amada | 71360091 | AM-Sensor cone, HS95 mini |
| AM343-1621* | AL601 | Amada | 71341621 | AM-Sensor cone, HS95 |
| AM343-9107 | AL603 | Amada | ECO cone | AM-Sensor cone, ECO |
| AM343-1690 | AL602 | Amada | 71341690 | AM-Sensor cone, HS98 |
| AM343-L3015C | AL550 | Amada | 71374509 | PT-Sensor cone, LC3015 |
| AM343-4233B* | AL551 | Amada | 71564233 | AM-Sensor cone, HPL Black |
| AM343-4233G* | AL552 | Amada | 71564233 | AM-Sensor cone, HPL Gold |
| PT347-3323 | AL611 | Mazak | HNP | PT-Sensor cone, HNP |
| MZ335-HNPS* | AL605 | Mazak | HNPS | MZ-Sensor cone, HNP short version |
| PT347-0007 | | Mazak | 56743300500 | PT-Sensor cone, HNZ (Mazak) |
| PT347-0011* | AL607 | Mitsubishi | P0354-110-00002 | PT-Sensor cone, HNZ (Mitsubishi) |
| MB334-W429A | AL604 | Mitsubishi | P0461-270-00001 | MB-Sensor cone, W429A |
| PT347-0238* | AL608 | Precitec | BQ930D238G01 | PT-Sensor cone, HNZ SMA |
| PT347-8001 | AL612 | Precitec | P0361-203-00001 | PT-Sensor cone, 2.5Z/J |
| PT347-0522* | AL609 | Precitec | P0599-520-00002 | PT-Sensor cone, LRC |
| PT347-1145 | AL610 | Precitec | P0380-140-0002, P0380-130-00001, 281145 | PT-Sensor cone, DZ |

*Sensor cone repair service is available for most sensor cones in North America and select international regions. For more information contact Ctlaser@Hypertherm.com.

Centricut is not affiliated with the named manufacturers. Reference to machines, parts, descriptions, and model numbers are for convenience in verifying compatibility only. All parts are made by or for Centricut and are not made by the referenced manufacturers (unless expressly indicated). Centricut is a registered trademark of Hypertherm, Inc. All other trademarks are the properties of their respective owners.

Armored sensor cables

Centricut armored sensor cables outlast standard OEM cables

- Available for all major brands
- Robust design with extreme temperature rating (900–1200°)
- Longer life reduces downtime and production loss
- Spatter resistant stainless steel armoring
- Reinforced collars and high-quality connector

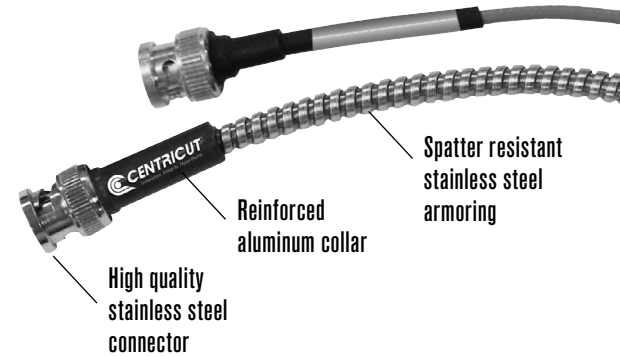

Armored sensor cables

| Centricut part number | Esse A part number | OEM | Reference number | Description |
|-----------------------|--------------------|------------------|---------------------------|--|
| AM308-8965 | AL260 | Amada | 71398965 | AM-Sensor cable, 305 mm (12") |
| AM308-8965A | AL613 | Amada | 71398965 | AM-Sensor cable, 305 mm (12") armored |
| AM313-1901 | AL200 | Amada | 71341630 | AM-Sensor cable HS-5, 305 mm (12") |
| AM313-1901A | | Amada | 71341630 | AM-Sensor cable HS-5, 305 mm (12") armored |
| AM313-8292 | AL615 | Amada | 71398292 | AM-Sensor cable dual shield, 7 m (275.6") |
| AM313-9851A | | Amada | 71369851 | AM-Sensor cable, 203 mm (8") armored |
| CN306-0654A | AL616 | Cincinnati | 909654, 922686 | CN-Sensor cable, 114 mm (4.5") armored |
| CN306-0951A | AL617 | Cincinnati | 842951 | CN-Sensor cable, 140 mm (5.5") armored |
| CN306-2951 | AL618 | Cincinnati | 842951, PLTTW0015 | CN-Sensor cable, 140 mm (5.5") |
| CN306-9654 | AL619 | Cincinnati | 909654, 922686, PLTTW0002 | CN-Sensor cable, 114 mm (4.5") |
| MZ335-0111A | AL620 | Mazak | 4674330111 | MZ-Sensor cable, 280 mm (11") armored |
| MZ335-0181A | AL621 | Mazak | 46743300181 | MZ-Sensor cable, 317.5 mm (12.5") armored |
| MZ335-1330A | AL622 | Mazak | 46683301330 | MZ-Sensor cable, 305 mm (12") armored |
| MZ335-1980A | AL643 | Mazak | 46683301980 | MZ-Sensor cable, 280 mm (11") armored |
| MZ335-5320 | AL105 | Mazak | 6143355320 | MZ-Sensor cable, 61.5 mm (2.4") armored |
| MZ335-630A | AL623 | Mazak | 00BSBA630MNC | MZ-Sensor cable, 630 mm (25") armored |
| MZ335-8290 | AL368 | Mazak | 46143308290 | MZ-Sensor cable, 75 mm (3") |
| NT426-1682 | AL624 | NTC | 4R029911-001, J482D | NT-Sensor cable, 216 mm (8.5") |
| NT426-4991 | AL625 | NTC | 3-0104991 | NT-Sensor cable 0-0BNC/MCX, 482 mm (19") |
| NT426-7492 | AL626 | NTC | 3-0117492 | NT-Sensor cable 90BNC/90BNC, 482 mm (19") |
| NT426-8677 | AL627 | NTC | 4R028677-001 | NT-Sensor cable, 508 mm (20") armored |
| PR361-3150 | AL628 | Prima | 820.63.150 | PR-Sensor cable, 150 mm (5.9") |
| PR361-3151 | AL629 | Prima | 820.63.150 | PR-Sensor cable, 150 mm (6") high profile |
| PR361-3160 | AL560 | Prima | 555.63.150 | PR-Sensor cable, 210 mm (8 17/64") |
| PT347-0101A | AL633 | Precitec | P0360-100-00500 | PT-Sensor cable, 500 mm (20") armored |
| PT347-0181 | AL358 | Precitec | 46743300181 | PT-Sensor cable, 305 mm (12") armored |
| PT347-0300A | AL635 | Precitec | P0492-014-00300 | PT-Sensor cable KE, 300 mm (11.8") armored |
| PT347-0450 | | Precitec | P0497-002-00450 | PT-Sensor cable, 450 mm (17.7") |
| PT347-KS13 | AL639 | Precitec/ Gunkyo | 00BMTKA-A-HS500mm | PT-Sensor cable, 390 mm (15.5") armored |
| PT347-1250 | AL637 | Precitec | D5001-040-00250 | PT-Sensor cable, 250 mm (9.8") armored |
| TR301-0930 | AL640 | Trumpf | 280930 | TR-Sensor cable, 152 mm (6") armored |
| TR301-7833 | AL641 | Trumpf | 227833 | TR-Sensor cable, 432 mm (17") |
| TR301-9983 | AL642 | Trumpf | 359983, 342474 | TR-Sensor cable, 190 mm (7.5") armored |

Centricut is not affiliated with the named manufacturers. Reference to machines, parts, descriptions, and model numbers are for convenience in verifying compatibility only. All parts are made by or for Centricut and are not made by the referenced manufacturers (unless expressly indicated). Centricut is a registered trademark of Hypertherm, Inc. All other trademarks are the properties of their respective owners.

Lens cleaning tips



Centricut supplies suitable for all OEM CO₂ and fiber laser lenses

- Lens maintenance base is designed to secure a wide range of optics sizes for the cleaning process
- Centricut optical cleaning fluid is a safe, economical alternative to traditional high-purity and reagent-grade solvents
- Cleaning materials suited for all lens cleaning needs; lens paper, polyester swabs and polyester wipes

Lens paper

Recommended for the routine maintenance cleaning of flat lenses.

Polyester swabs

Recommended for cleaning curved lenses and where a more aggressive cleaning is required (interchangeable with polyester wipes).

Polyester wipes

Recommended for cleaning CO₂ and fiber lenses and windows (interchangeable with polyester swabs and lens paper).

| Product description | Part number | Quantity per order |
|--------------------------------|-------------|--------------------|
| Optical cleaning fluid (3 oz.) | TR300-1112 | 1 |
| Lens cleaning swab | TR300-0699 | 25 |
| Lens cleaning paper, Tiffen | TR300-6452 | 50 |
| Polyester wipes 4" x 4" | TR300-7991 | 100 |
| Base, lens maintenance | TR300-271 | 1 |

Lens paper

Recommended for the routine maintenance cleaning of flat lenses.

You will need:

- Lens maintenance base (lens holder)
- Optical cleaning fluid
- Air bulb
- Lint-free lens paper
- Latex or rubber gloves

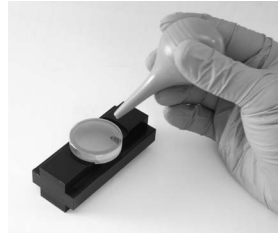

To get started

Using rubber gloves, place the lens in the lens holder and remove all loose contaminants with an air bulb. When contaminants are no longer visible, begin the cleaning process.

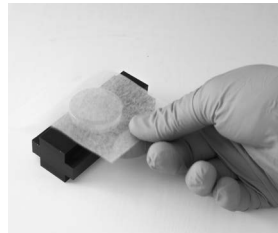

Step 1

Place lens paper over the optic, covering it completely.



Step 2

Apply a couple drops of lens cleaning fluid to the lens paper (far side of the lens).

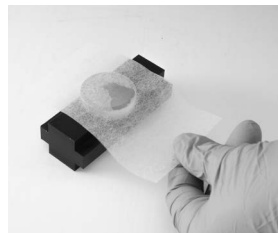

Step 3

Slowly pull the lens paper across the lens so the cleaning fluid comes in contact with the entire lens surface. Finish pulling the paper across so all of the fluid has dried from the lens.

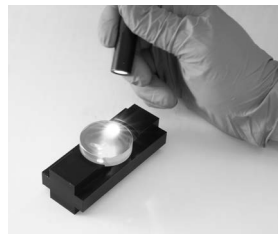

Step 4

Inspect the surface of the lens for dust and cleaning residue using a flashlight. Examine the lens from different angles. Repeat the process on the other side of the lens.

Final step:

Place the cleaned lens in the machine quickly to avoid contamination from airborne particles. If spots, pits, or scratches are still noticeable, the lens may need to be replaced.

Centricut is not affiliated with the named manufacturers. Reference to machines, parts, descriptions, and model numbers are for convenience in verifying compatibility only. All parts are made by or for Centricut and are not made by the referenced manufacturers (unless expressly indicated). Centricut is a registered trademark of Hypertherm, Inc. All other trademarks are the properties of their respective owners.

Polyester swabs

Recommended for cleaning curved lenses and where more aggressive cleaning is required. Interchangeable with polyester wipes.

You will need:

- Lens maintenance base (lens holder)
- Optical cleaning fluid
- Air bulb
- Polyester swabs
- Latex or rubber gloves

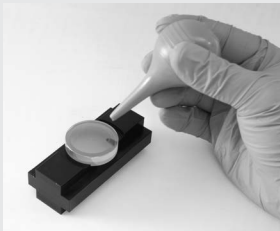

To get started

Using rubber gloves, place the lens in the lens holder and remove all loose contaminants with an air bulb. When contaminants are no longer visible, begin the cleaning process.



Step 1

Place a few drops of the optical cleaning fluid onto the swab.

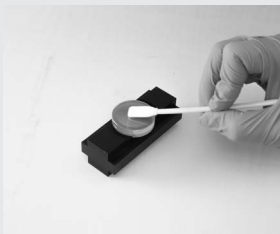

Step 2

Move the larger dirt particles and then finer contaminants to the edge of the lens using the swab. Do not rest the swab on the lens or on the work table. Do not reuse swabs.



Step 3

Inspect the surface of the lens for dust and cleaning residue using a flashlight. Examine the lens from different angles. Repeat the process on the other side of the lens.

Final step:

Place the cleaned lens in the machine quickly to avoid contamination from airborne particles. If spots, pits, or scratches are still noticeable, the lens may need to be replaced.

Polyester wipes

Recommended for cleaning CO₂ and fiber lenses and windows. Interchangeable with polyester swabs and lens paper.

You will need:

- Lens maintenance base (lens holder)
- Optical cleaning fluid
- Air bulb
- Polyester wipes
- Latex or rubber gloves



To get started

Using rubber gloves, place the lens in the lens holder and remove all loose contaminants with an air bulb. When contaminants are no longer visible, begin the cleaning process.



Step 1

Place a few drops of the optical cleaning fluid onto the polyester wipe.



Step 2

Place the wipe with the wet side down on the lens and slide it across the lens, applying light pressure to the top of the wipe. Avoid contamination to the wipe and do not reuse wipes.

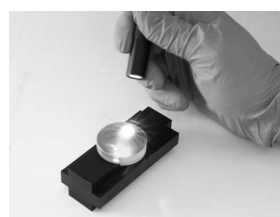

Step 3

Inspect the surface of the lens for dust and cleaning residue using a flashlight. Examine the lens from different angles. Repeat the process on the other side of the lens.

Final step:

Place the cleaned lens in the machine quickly to avoid contamination from airborne particles. If spots, pits, or scratches are still noticeable, the lens may need to be replaced.

Steps to help optimize cut quality.

Striation marks, angularity and dross tell the story.

Optimizing CO₂ and fiber lasers to achieve maximum cut quality is a very important step in the overall cutting process. The critical points that produce good cuts are the width of the kerf (the material that is lost during the cut), oxidation and roughness of the cut surface, the geometry of the cut parts and the allowable tolerances. Some factors to be considered are the cut speed or 'feed rate', beam focus, gas pressure, standoff and nozzle size/type.

Factory cut chart settings

The following samples show 12 mm, 6 mm and 3.2 mm (1/2", 1/4" and 10 ga.) mild steel, cut with O₂ on a 2 kW fiber laser with one variable changed to show how cut quality is affected. The adjustments will be similar for all CO₂ and fiber laser, cutting mild steel with O₂.

Is the kerf too narrow?

When the kerf is too narrow the cut will have a very smooth edge on the top, a lack of oxidation on the bottom and/or heavy dross.

Probable causes:

- Focus is too low
- Feed rate is too fast
- Gas pressure is too low
- Nozzle size is too small
- Standoff is too low

Follow these steps to optimize cut quality:

1. Use the closest known settings for the material being cut.
2. Use a test part that has both interior and exterior features.
3. Verify that the lens and/or window is clean and in good condition.
4. Verify that the nozzle is centered properly and is in good condition.
5. Adjust the focus up and down until the cut quality starts to get bad and then set to the middle of that range.
6. Adjust the gas pressure up and down until the cut starts to get bad and then set to the middle of that range.
7. Adjust the feed rate up by 5% increments. When the cut starts to get bad, set the feed rate 10% slower.

Strike a balance between heat levels and gas flow

Cutting mild steel with a laser is a balance of how much material is heated by the laser beam and how much assist gas flows through the cut.

- Heating up too small of an area, or not having enough assist gas flow through the cut will result with the kerf (width of the cut) being too narrow.
- Heating up too large of an area or having too much assist gas flow through the cut will result in the kerf being too wide.

Is the kerf too wide?

When the kerf is too wide the cut will have a rougher edge, more self burning in the corners of the part, more angularity on the cut edge and occasionally, dross.

Probable causes:

- Focus is too high
- Feed rate is too slow
- Gas pressure is too high
- Nozzle size is too big
- Standoff is too high
- Incorrect nozzle type

3.2 mm (10 ga.) mild steel cut resulting in too narrow kerf

Factory cut chart settings

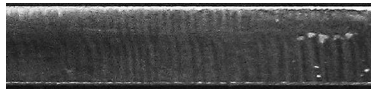

Focus is too low

The kerf is too narrow and doesn't allow enough O₂ into the cut to remove all the molten material.

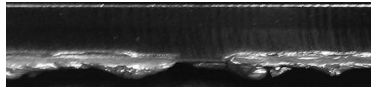

Feed rate is too fast

The cut striations are trailing the direction of cutting and there is not enough time to remove all the molten material.

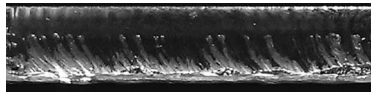

Gas pressure is too low

There is not enough O₂ to remove all the molten material.

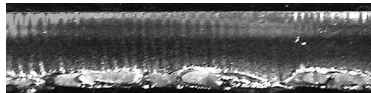

Stand off is too low

The focus spot is in the wrong location, causing the rough edge.

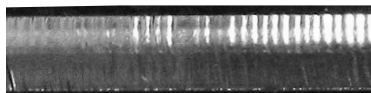

3.2 mm (10 ga.) mild steel cut resulting in too wide kerf

Factory cut chart settings



Focus is too high

The laser is melting more material than can be removed from the cut.

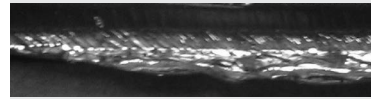

Feed rate is too slow

The cut surface is too rough and productivity is decreased.

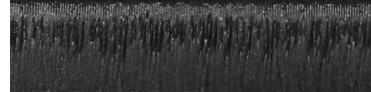

Gas pressure is too high

Too much O₂ results in overheating of the cut and causes intermittent gouges.

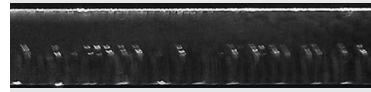

Stand off is too high

The laser is melting more material than can be removed from the cut.

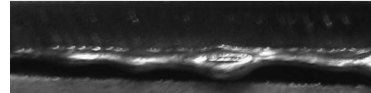

Nozzle size is too big

Too much O₂ results in overheating of the cut and causes intermittent gouges.

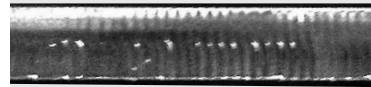

*Above samples have been cut with O₂ on 2 kW fiber laser. Results will be similar for CO₂ laser cutting mild steel with O₂.

6 mm (1/4") mild steel cut resulting in too narrow kerf

Factory cut chart settings

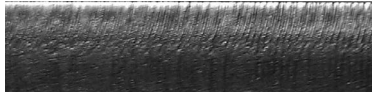

Focus is too low

The kerf is too narrow and doesn't allow enough O₂ into the cut to remove all the molten material.

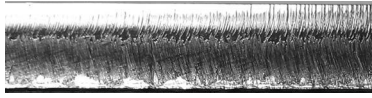

Feed rate is too fast

The cut striations are trailing the direction of cutting and there is not enough time to remove all the molten material.

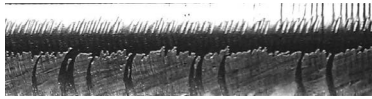

Gas pressure is too low

There is not enough O₂ to remove all the molten material.

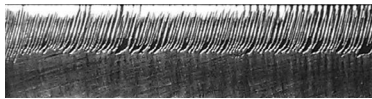

Stand off is too low

The focus spot is in the wrong location, causing the rough edge.

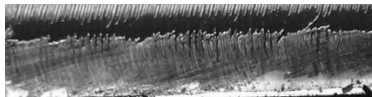

Nozzle size is too small

There is not enough O₂ to cut uniformly.

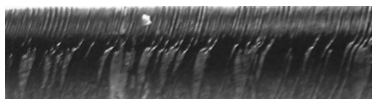

6 mm (1/4") mild steel cut resulting in too wide kerf

Factory cut chart settings

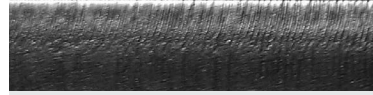

Focus is too high

The wider focus spot is letting too much O₂ into the cut and burning the material.

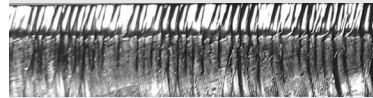

Feed rate is too slow

The cut surface is too rough and productivity is decreased.

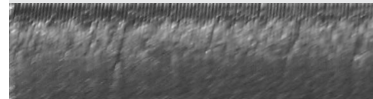

Gas pressure is too high

Too much O₂ is entering the cut, causing a rougher edge and inconsistent cutting.



Stand off is too high

Too much O₂ is entering the cut, causing a rougher edge and inconsistent cutting.

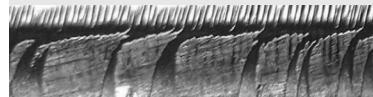

Nozzle size is too big

Too much O₂ results in overheating of the cut and causes intermittent gouges.



Nozzle type is incorrect

The shape of the gas flow is incorrect, causing a rougher edge.

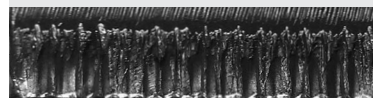

Cut direction

Cut direction

*Above samples have been cut with O₂ on 2 kW fiber laser. Results will be similar for CO₂ laser cutting mild steel with O₂.

Centricut is not affiliated with the named manufacturers. Reference to machines, parts, descriptions, and model numbers are for convenience in verifying compatibility only. All parts are made by or for Centricut and are not made by the referenced manufacturers (unless expressly indicated). Centricut is a registered trademark of Hypertherm, Inc. All other trademarks are the properties of their respective owners.

12 mm (1/2") mild steel cut resulting in too narrow kerf

Factory cut chart settings

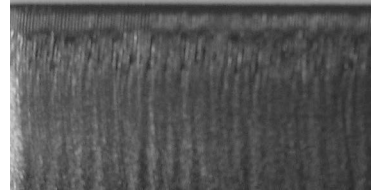
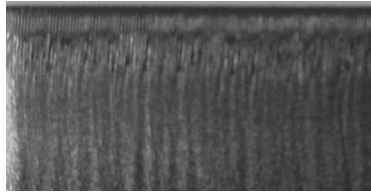

Factory cut chart settings

Focus is too low

The kerf is too narrow and doesn't allow enough O₂ into the cut to remove all the molten material.

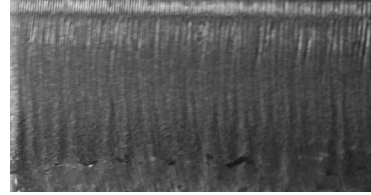
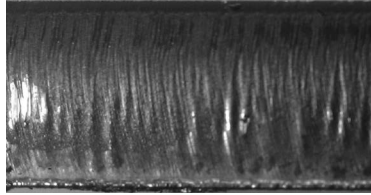

Stand off is too low

The kerf is too narrow to allow enough O₂ into the cut. The oxidation is not covering the entire surface and cutting will be inconsistent.

Feed rate is too fast

The machine is moving too fast to allow enough O₂ into the cut for consistent cutting.

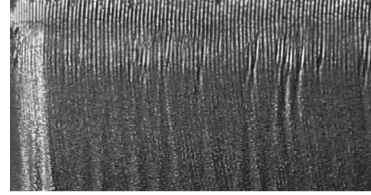
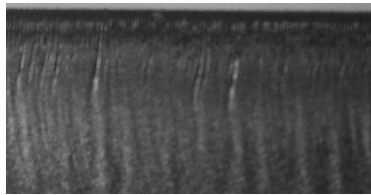

Nozzle size is too small

There is not enough O₂ to cut uniformly.

Gas pressure is too low

The pressure is too low to allow enough O₂ into the cut. The oxidation is not covering the entire surface and cutting will be inconsistent.



Cut direction

Cut direction

*Above samples have been cut with O₂ on 2 kW fiber laser. Results will be similar for CO₂ laser cutting mild steel with O₂.

Centricut is not affiliated with the named manufacturers. Reference to machines, parts, descriptions, and model numbers are for convenience in verifying compatibility only. All parts are made by or for Centricut and are not made by the referenced manufacturers (unless expressly indicated). Centricut is a registered trademark of Hypertherm, Inc. All other trademarks are the properties of their respective owners.

12 mm (1/2") mild steel cut resulting in too wide kerf

Factory cut chart settings

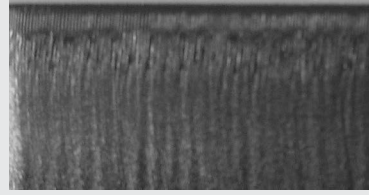
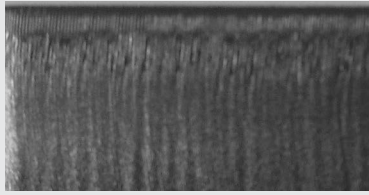

Factory cut chart settings

Focus is too high

Too much O₂ is entering the cut causing intermittent over burning.

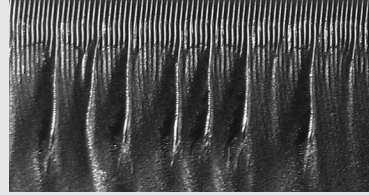
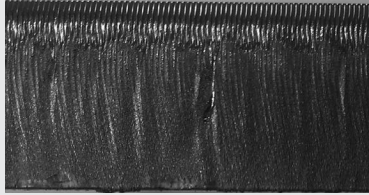

Stand off is too high

Too much O₂ is entering the cut resulting in intermittent over burning.

Feed rate is too slow

The machine is moving too slow resulting in the over burning of the bottom half of the cut. The slower feed rate also reduces productivity.

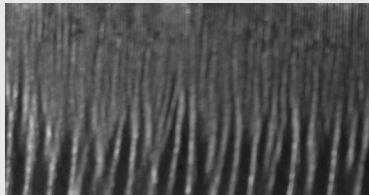

Incorrect nozzle type

The gas flow shape is not correct resulting in inconsistent cutting.

Gas pressure is too high

Too much O₂ is entering the cut resulting in intermittent over burning.

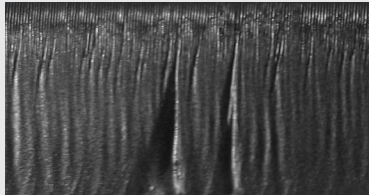

*Above samples have been cut with O₂ on 2 kW fiber laser. Results will be similar for CO₂ laser cutting mild steel with O₂.

Centricut is not affiliated with the named manufacturers. Reference to machines, parts, descriptions, and model numbers are for convenience in verifying compatibility only. All parts are made by or for Centricut and are not made by the referenced manufacturers (unless expressly indicated). Centricut is a registered trademark of Hypertherm, Inc. All other trademarks are the properties of their respective owners.

Technical support and customer service

Our technical service team can answer questions about any laser cutting system. Whether it's a question about a part, a system or for guidance on how to optimize laser cutting performance, our experts can help.

- OEM trained technicians with over 40 years experience
- Free application support for all laser OEMs
- We stand behind our products with industry-leading technical expertise



Contact a laser expert at ctlaser@hypertherm.com

HELPING YOU SHAPE THE WORLD.



PLASMA | LASER | WATERJET | AUTOMATION | SOFTWARE | CONSUMABLES

For more information on Centricut laser products,
visit www.hypertherm.com/laserconsumables
or email ctlaser@hypertherm.com

Hypertherm, Centricut, SilverLine and CoolFlow are trademarks of Hypertherm, Inc., and may be registered in the United States and/or other countries. All other trademarks are the property of their respective owners.

Please visit www.hypertherm.com/patents for more details about Hypertherm patent numbers and types.

© 6/2021 Hypertherm, Inc. Revision 10

As 100% Associate-owners, we are all focused on delivering a superior customer experience. www.hypertherm.com/ownership

Environmental stewardship is one of Hypertherm's core values. www.hypertherm.com/environment

100% Associate-owned



Hypertherm[®]
SHAPING POSSIBILITY[®]